

## SHOCK CORD ADJUSTMENT

You must use the shock cord available through Concept2. Use of other shock cord will have a significant effect on the performance of your machine. Concept2 part number PN 1731.



1. Detach flywheel section and turn upside down.



2.

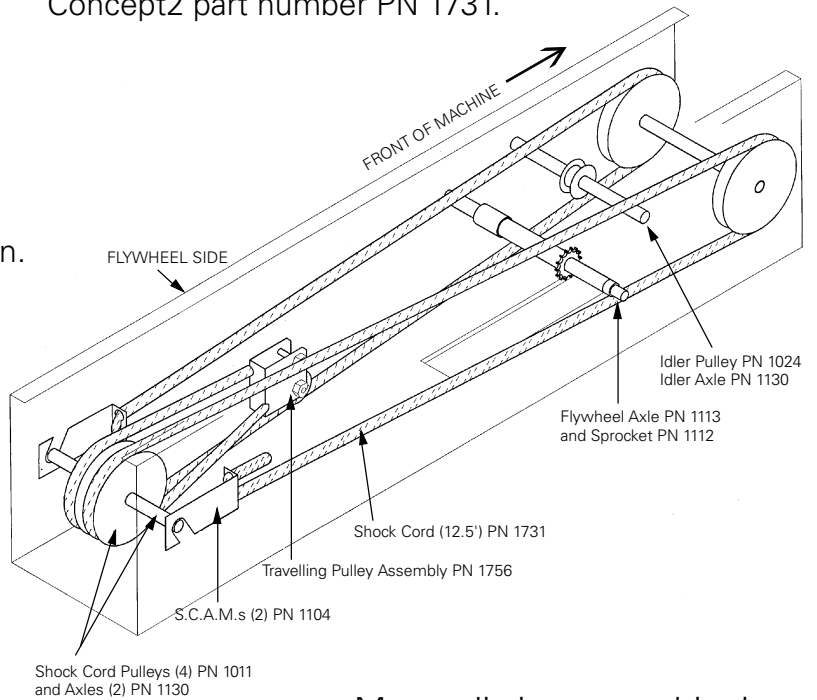

Monorail shown upside down.

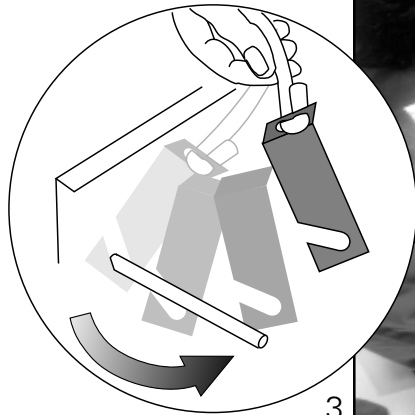

3.

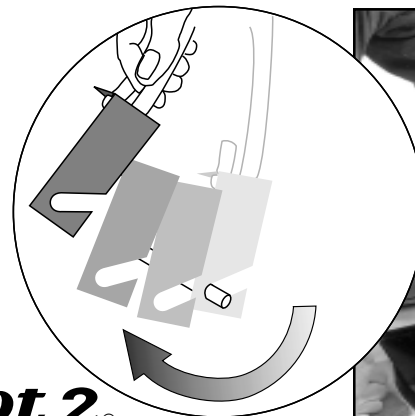
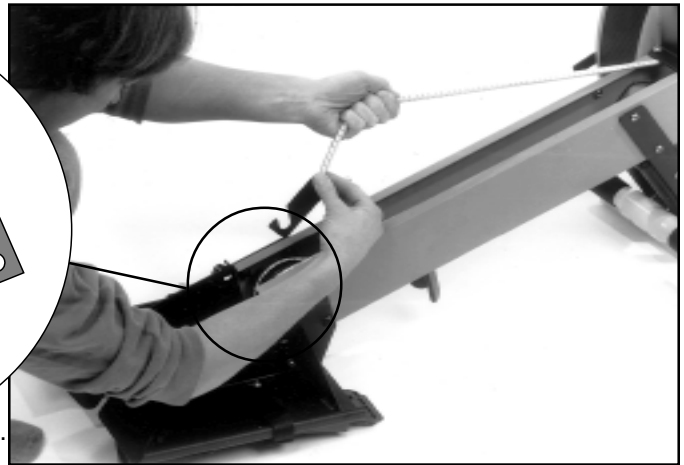

4.

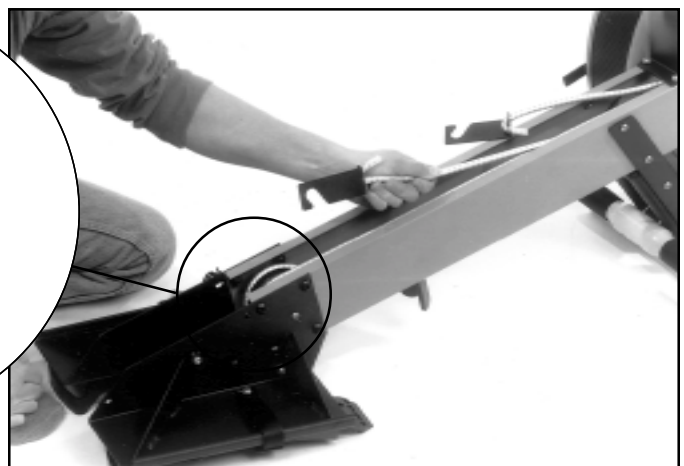

5.

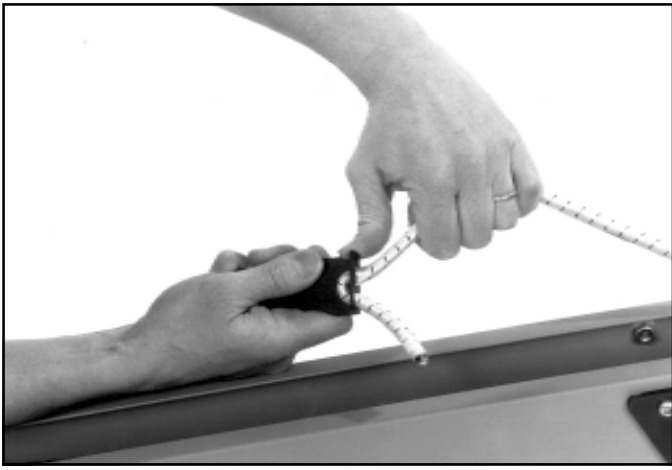

7.

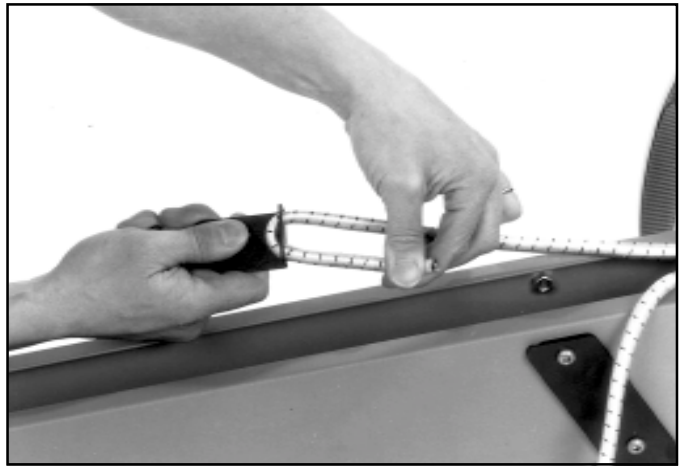

Push equal amounts of cord through both shock cord adjustment mechanisms.

6.



8.



9.

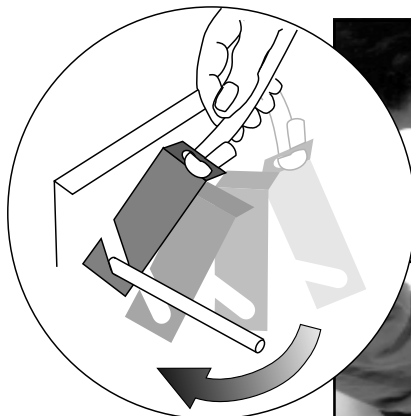
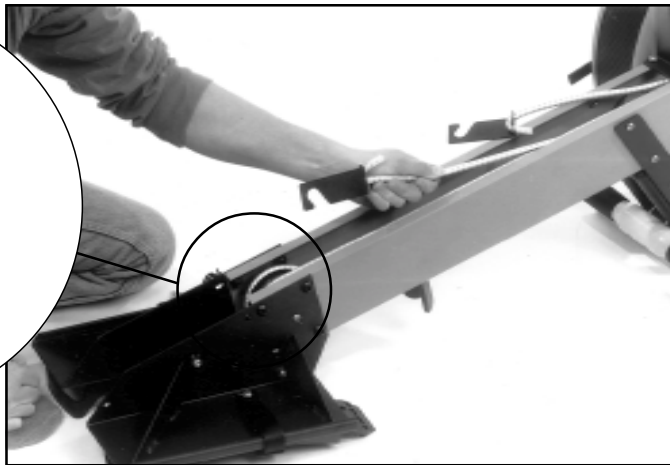

10.

